

Features

- Two-piece toilet.
- Elongated bowl offers added room and comfort.
- 1.28 gallons per flush (gpf).
- Comfort Height® feature offers chair-height seating that makes sitting down and standing up easier for most adults.
- Combination consists of the K-4397 bowl and the K-4438 tank.
- Coordinates with other products in the Devonshire collection.

Technology

- Single-flush gravity uses the force of gravity and a precision-engineered tank, bowl, and trapway to create a strong siphon during flushing.
- AquaPiston canister allows water to flow into the bowl from all sides (360 degrees), increasing the power and effectiveness of the flush.
- Flush valve's 3:2 ratio harnesses the natural force of gravity and optimizes flush performance.
- Durable canister design has 90% less exposed seal material than a 3-inch flapper, for leak-free performance.
- Light-touch canister flush requires a lower actuation force than a flapper.
- AquaPiston canister flush valve optimizes flush performance and resists warping and deterioration.

Installation

- Standard 12-inch rough-in.
- Three-bolt installation.
- Seat and supply line not included.

Water Conservation & Rebates

- WaterSense® toilets meet strict EPA flushing guidelines, including using at least 20 percent less water than 1.6-gallon toilets.
- Eligible for consumer rebates in some municipalities.
- This product meets water savings requirements for California Energy Commission (CEC), CALGreen, and Colorado SB 14-103.

Recommended Accessories

- K-4636 Cachet® Quiet-Close™ Elongated Toilet Seat
- K-5588 Purefresh® Elongated Toilet Seat
- K-4108 C3®-230 Elongated Cleansing Toilet Seat
- K-5420 Low-Profile Bolt Caps
- K-9167-L Trip Lever
- K-484 Trip Lever
- 1023457 Wax Ring/Hardware Kit
- 1265114 Connector Hose



ADA **CSA B651** **OBC**

Codes/Standards









ASME A112.19.2/CSA B45.1
DOE - Energy Policy Act 1992
EPA WaterSense®
California Energy Commission (CEC)
ADA
ICC/ANSI A117.1
CSA B651
OBC

KOHLER® One-Year Limited Warranty

See website for detailed warranty information.

Available Color/Finishes

Color tiles intended for reference only.

| Color | Code | Description |
|--|------|---------------|
|  | 0 | White |
|  | 96 | Biscuit |
|  | 47 | Almond |
|  | NY | Dune |
|  | 95 | Ice™ Grey |
|  | G9 | Sandbar |
|  | K4 | Cashmere |
|  | 58 | Thunder™ Grey |
|  | 7 | Black Black™ |

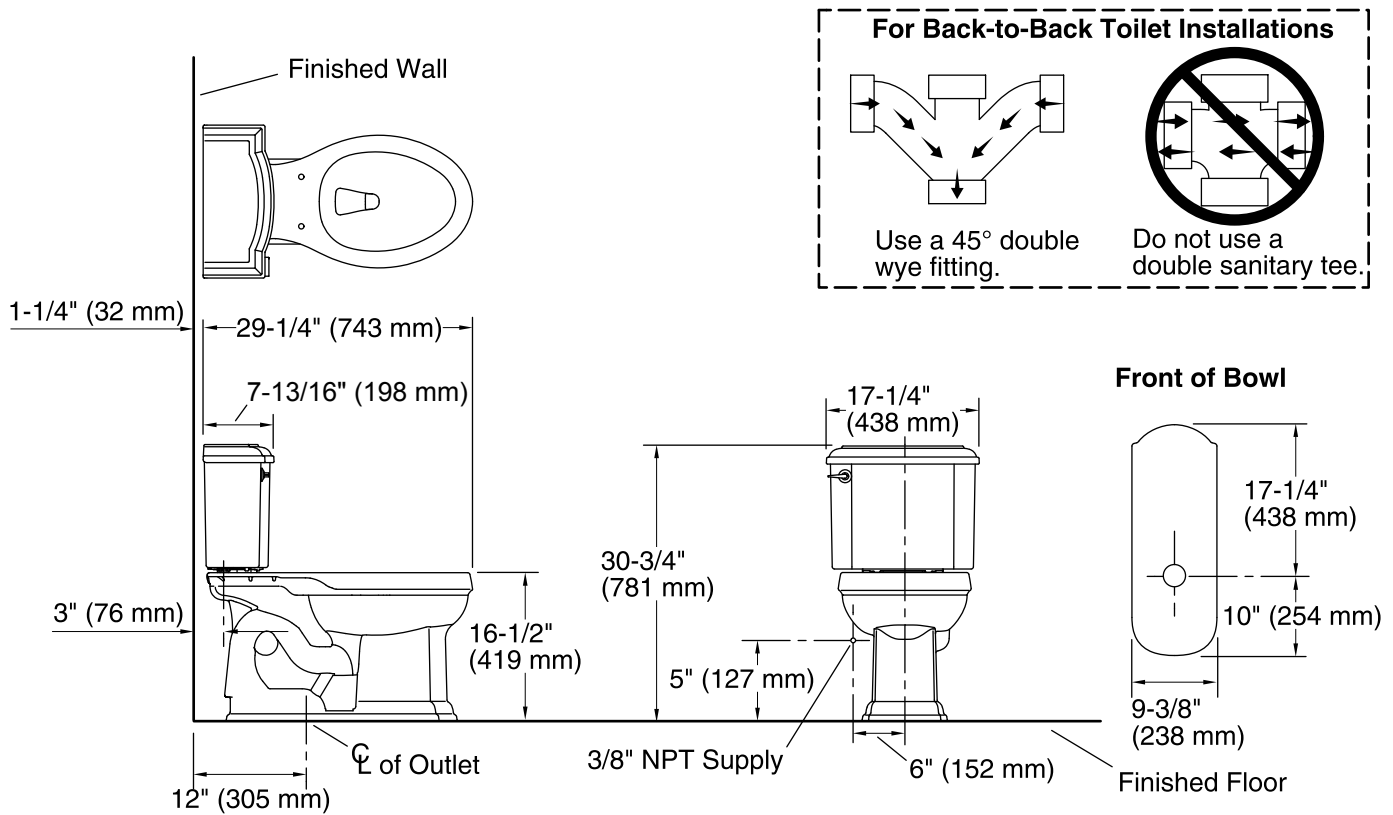

Technical Information

All product dimensions are nominal.

| | |
|-----------------------|------------------------------------|
| Toilet type: | Two-piece, Floor-mount |
| Waste Outlet: | Floor |
| Bowl shape: | Elongated front |
| Flush type: | AquaPiston® |
| Trap passageway: | 2-1/8" (54 mm) |
| Water Consumption | |
| Full: | 1.28 gpf (4.8 lpf) |
| Water surface size: | 11-1/2" x 8-3/4" (292 mm x 222 mm) |
| Rim to water surface: | 5-1/2" (140 mm) |
| Rough-in: | 12 |
| Seat-mounting holes: | 5-1/2" (140 mm) |

Notes

Install this product according to the installation instructions.

For back-to-back toilet installations: Use only a 45° double wye fitting.

ADA, OBC, CSA B651 compliant when installed to the specific requirements of these regulations.

Plumbing codes may require elongated toilets and elongated, open-front seats in public bathrooms.

Accessibility standards may require controls to be located on the open side of the toilet.